

## 3310 SERIES

# INSTALLATION INSTRUCTIONS



TPI Corporation  
P.O. Box 4973  
Johnson City, TN  
37602-4973

America's Comfort Conditioning Company

### 1. LOCATION OF HEATER:

- Heater is mounted on the wall near ceiling or floor, air flow down.  
**CAUTION:** Do not obstruct the front grille of the heater with curtains, furniture, etc., since the proper operation of the heater requires a free flow intake and exhaust of air.
- Minimum mounting height is 8" above finished floor.
- For surface mounting use adapter FQP/3310EX33.

### 2. BEFORE MOUNTING:

- Insure that the supply voltage matches voltage rating on the label of the heater.
- Turn off electrical power to heater circuit.

### 3. MOUNTING INSTRUCTIONS:

- Disassemble heater by removing 7 screws "C" as shown in Figure 1 and 2.
- Flush mounting, see Fig. 1.  
Place rough-in box "A" between studs at desired height: secure to studs through holes "M". The flanges on the rough-in box must rest on the surface of the finished wall; if the box is installed prior to the application of the finished wall, allowance must be made for the wall thickness.
- Surface mounting, See Fig. 2.  
Insert rough-in box "A" into surface adapter "E". Secure the heater rough-in box to wall at desired height through holes "X". Be sure that the rough in box is centered in surface adapter. For surface mounting, bring wiring through bottom knockout "K" only.
- Place assembly "B" into rough-in box "A". Secure with six screws "C".

### 4. WIRING INSTRUCTIONS REF: Diagrams WD1, WD2, WD3, WD4.

- Field Conversion for Lower Wattage:** All units are factory wired for higher wattage rating. (See paragraph 9 for conversion to lower wattage rating).
- Bring service leads through knockout "K" on top or bottom of rough-in box for flush or semi-recessed mounting, bottom knockout "K" only for surface mounting. When wiring from the bottom, install wire through cover "G" by removing screw "H".
- Attach service leads to two black leads on 208-240 volt models and to black and white leads on 120-277 volt models, attach ground lead to green wire with approved connectors. Comply with all national and local codes.
- Attach wiring compartment cover "D" to assembly with screw "C".

### 5. FINAL STEPS:

- Clean all construction dirt and debris from inside heater.
- Attach front grille "F" with four screws "L". A parts bag containing the cover screws and the thermostat knob is located inside of heater.
- Attach thermostat knob "T".

### 6. OPERATING INSTRUCTIONS:

- Turn on power at the circuit breaker panel.
- If there are two controls on the front grille of the heater; the one on your left "T" is the thermostat control and should be set to the position to give the desired comfort heat in the room. The switch on your right is the mode selection switch. Two modes of heating operation are available: **CONSTANT:** Fan runs continuously while thermostat cycles heating elements on and off as required by setting; and **AUTO:** Fan and heating elements cycle on and off simultaneously on thermostat control. The fan can be operated separately to circulate room temperature air by turning thermostat to its lowest setting and placing fan selector switch in the "CONSTANT" position.
- After the desired temperature is reached, turn thermostat stem counter clockwise until a click is heard from the thermostat.
- Models with double pole thermostats: Turn thermostat adjustment knob fully counter-clockwise to the "OFF" position. This will de-energize the heating element and fan.

### Wall Installation

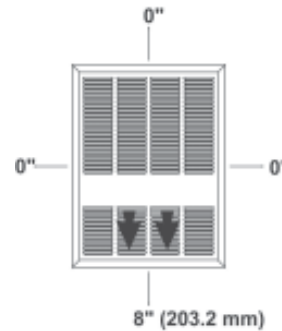

### 7. CLEANING AND MAINTENANCE INSTRUCTIONS:

- At the beginning of each heating season, disconnect electrical power at circuit breaker panel. Remove front grille.
- Use the narrow (crevice) suction attachment of the vacuum cleaner to remove dust and lint from heater and heating element.
- Lubricate the motor with SAE No. 10 oil. Two (2) oil spouts are located on front and back of motor.
- Reinstall front grille with previously removed screws. Restore power to the heater.

FIG. 1 FLUSH MOUNT

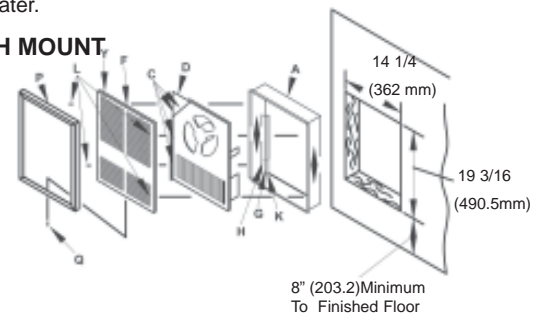
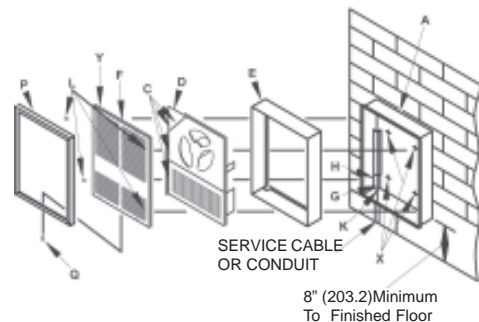

FIG. 2 SURFACE MOUNT



Note: This heater employs a visual alarm (light) to warn that parts of the heater are getting excessively hot. If the alarm illuminates, immediately disconnect power from heater and inspect for any objects on or adjacent to the heater that may cause high temperatures. **DO NOT OPERATE HEATER WITH THE ALARM (LIGHT) ILLUMINATED.**

Form 9821  
ECO 1-5672

**IMPORTANT: OWNER SHOULD RETAIN THESE INSTRUCTIONS FOR FUTURE REFERENCE**

# 3310 SERIES

TROUBLE SHOOTING		
Symptom	Possible Fault(s)	Remedy
Heater Does Not Operate	1. Electrical Circuit Open	1. A. Close electric circuit. B. Verify correct supply voltage. C. Adjust thermostat to higher setting.
	2. Defective Thermostat	2. Check continuity with an ohm meter. Replace defective part if necessary.
	3. Thermal Cut Out Open (Alarm Light On)	3. A. Remove any obstruction from front of heater B. Verify correct supply voltage.
Heat On But Fan Does Not Operate	1. Fan Motor Failure	1. A. Verify correct supply voltage. B. Check motor wiring connections. C. Replace defective motor if necessary.

**9. Field Conversion For Lower Wattage:** To convert heater to a lower wattage rating. Remove (Red Jumper) from heating element (See WD1, WD2, WD3 and WD4). The wattage will be reduced to half of the nameplate wattage. (See Figure 3 for model numbers rated dual wattage).

**FIGURE 3**

MODEL NO.	VOLTAGE	WATTAGE	AMPERAGE
E3313RP	120	1500	12.5
	120	750	6.25
HF3315RP	240/208	3000/2250	12.5/10.8
	240/208	1500/1125	6.2/5.4
HF3316RP	240/208	4000/3000	16.7/14.4
	240/208	2000/1500	8.3/7.2

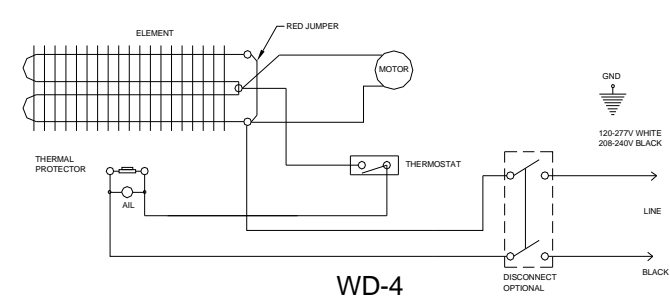
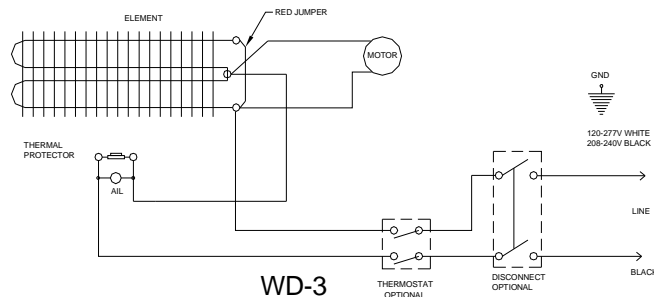
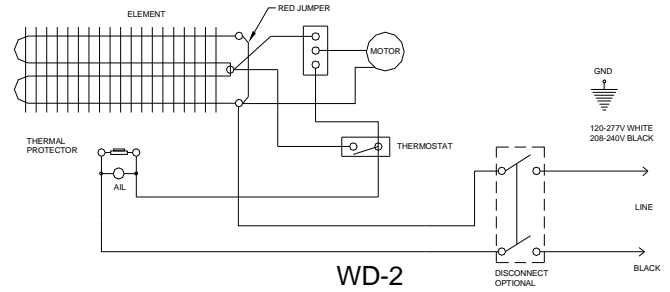
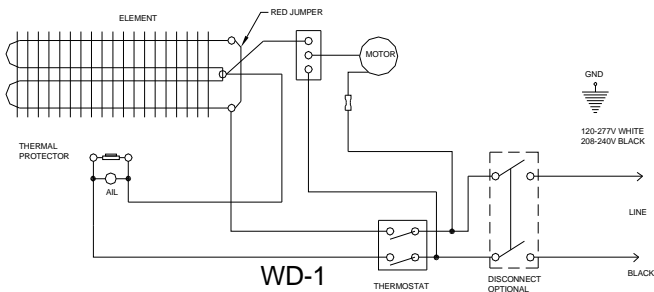

- WD-1 3310 with Summer Fan Switch, Double Pole T-Stat and (Optional Disconnect Switch)
- WD-2 3310 with Summer Fan Switch, Single Pole T-Stat and (Optional Disconnect Switch)
- WD-3 3310 with (Optional Double Pole T-Stat and Disconnect Switch)
- WD-4 3310 with Single Pole T-Stat and (Optional Disconnect Switch)

AIL Alarm Indicator Lights

Form 9821  
ECO 1-5672

**IMPORTANT: OWNER SHOULD RETAIN THESE INSTRUCTIONS FOR FUTURE REFERENCE**